

A SYSTEM OF STRUCTURAL RELATIONSHIPS IN PHYTOCHEMISTRY

J. ALFRED HALL¹

Forest Products Laboratory,² Forest Service, U. S. Department of Agriculture

Received May 5, 1937

INTRODUCTION

Phytochemistry, broadly defined, embraces not only the isolation and identification of the constituents of plants, the *materia phytochemica*, but the study of the physiological processes of plant life in their relationship to the products of plant metabolism. The former phase of the science has broadened its base immensely in recent years, and the annual increment in the discovery of hitherto unknown substances in plants and in the determination of the structure of those already known is considerable. The latter phase is still, for the most part, a sealed book. There is a vast gap in our knowledge of the processes that transpire between photosynthesis and the formation of the end products of metabolism; in not one case can we surely trace the steps that intervene.

The metabolic products that are isolated from plants are for the most part stable substances, although the worker in this field is perfectly familiar with phenomena constantly encountered that prove to his satisfaction the presence of many unstable bodies. Our technic has rarely been sufficiently refined to permit the isolation of other than those substances capable of enduring the relatively drastic methods employed. These are generally the stable end products of metabolism or substances formed artificially; the intermediates escape us.

These limitations upon technic are to a large degree unavoidable, since most of the substances intervening between the carbohydrates of photosynthesis and the final products of metabolism do not, in all probability, ever exist in large concentrations. Their nature may be conceived to be a very labile one and their existence transitory. Their isolation from the living plant appears to be improbable, and their fixation in plant material prepared for examination may prove to be impossible. The comparatively

¹ Now Associate Director, California Forest and Range Experiment Station, Berkeley, California.

² Maintained at Madison, Wisconsin, in coöperation with the University of Wisconsin.

simple problem of the fermentation of sugar by yeasts need only be cited to indicate the difficulties in the way of a real experimental approach to the intermediate processes of metabolism in the higher plants.

The lack of experimental methods has necessitated an approach to the problem along theoretical lines in which cognizance has been taken of such organic chemical experience as could be translated into biochemical thought and due regard given to such biological experience as could be translated into organic chemical thought. Noteworthy contributions in recent years have been made by Robinson (38, 39, 40), Smedley (49), Kremers (33), Astengo (2), Francesconi (26, 27), Read (37), Emde (10, 11, 12, 13, 14, 16, 17, 18, 19), Singleton (48), Schöpf (43, 44, 45), Schmalfuss (42), and Armstrong (1).

An excellent and complete critical review of the various theories propounded concerning the relationships of the sugars and their derivatives to various classes of naturally occurring substances has been given by Bernhauer (3). A similar review, in which the important theories of Collie are adequately treated, appears in the chapter on natural syntheses in Stewart's book (50). A large mass of literature has been built around the general thesis of the biogenetics of substances occurring in higher plants, but it is not the present purpose to present a review of all the contributions. Although many of the theories advanced have had only the merit of structural possibility, they have usually embodied ideas which contributed materially to the development of the field. A generalized point of view in which a coherent explanation of phytosyntheses has been attempted is lacking.

The theory of isoprene polymerization has been advanced by many authors in explanation of the formation of such substances as the terpenes, resin acids, polyene pigments, sterols, caoutchouc, and the like (4). Perhaps it is more accurate to state that, in most cases, authors have emphasized the occurrence of the isoprene unit in various forms of condensation rather than the supposition that isoprene itself is condensed in nature to form the varied products in which this fundamental unit appears; in other words, the relationship of the "isoprene family" to isoprene is mostly assumed to be a formal one, and not necessarily a biogenetic one. Wagner-Jauregg (51) accomplished the syntheses of the olefinic terpenes and their relatives under the mildest conditions yet observed, which still fall far short of realizing biological conditions. If a synthesis of terpenes could be carried out from isoprene under biologically probable conditions, the explanation of the formation of isoprene itself would still be wanting. The same reasoning may be applied to the idea of β -methylcrotonaldehyde as the fundamental unit of this family of compounds (20). Further, the structural relationship of the isoprene group to other associated groups would still be lacking.

While the recurrence of the isoprene unit in the structures of the more stable end products of plant metabolism has been most striking, especially in its relation to the elucidation of structures of many complex and baffling substances, many other structural regularities in plant products are discernible. Armstrong (1) has pointed out a number of them, and Emde (13, 14, 15, 17, 18) may well be said to have formulated a "reconstructive biochemistry" upon the basis of such regularities.

Schöpf (43, 44, 45) has defined a technic and has carried out most interesting investigations in the synthesis of the *Angostura* and other alkaloids under physiological conditions from materials suggested largely as a result of "reconstructive" reasoning. According to Schöpf, the formation of natural substances in the living cell may be of three types: In the first, the cell may have an enzymatic system designed for the highly specific synthesis of a certain substance. An example is the formation of starch in the assimilation of carbon dioxide. The second type is enzymatic but general, that is, the result of processes of general application catalyzed by enzymes, e.g., hydrogenation, dehydrogenation, and decarboxylation. The third case is of the synthesis of natural substances, or stages of such synthesis, without the action of enzymes. Such cases are characterized by the formation in the growth of the cell of organic substances so reactive that they, upon contact in the cell, yield isolable products which are, in effect, chance products, or stages in the production of such.

The technic or reasoning process of Emde and Schöpf, used also in part previously (28) by the author of the present paper, starts with the final product of metabolism, the structure of which must be known. At the other end of the road, serving as guideposts, stand the natural hexoses and their closer relatives. One must work backward step by step toward this beginning, with only such guidance as is afforded by our comparatively meagre information concerning reactions under biological conditions. The intermediate products may never be any more apparent than are those in an ordinary alcoholic fermentation.

Schöpf makes the important reservation that no broad conclusions as to precursors can be drawn from the constitution of an individual substance. However, if one has a large number of natural products of related constitution, as is the case today in many groups, there is possible a sort of "comparative anatomy" of analogies and regularities in make-up, from which one can draw probable conclusions concerning the precursors. Also, an important method of testing conclusions as to biogenetic relationships is the systematic survey of the occurrence in plants of substances supposed to be biogenetically related. This method must, however, be used with great care, since it is apt to mislead the investigator. The difficulty arises from the fact that often where substances may appear to be biogenetically related and perhaps derivable from one another, in

fact they are more probably derived from a common precursor in which the necessary configuration has been established, but have followed different routes in subsequent elaboration. In most groups, accurate knowledge of occurrences and cooccurrences is too limited as yet to warrant the use of this method.

THE KEY POSITION OF QUINIC ACID

A case in point may well be the relationship existing structurally between quinic acid and citric acid, which will be developed in the subsequent argument. The two acids occur widely, but those plants noted for their quinic acid content are not producers of citric acid, and *vice versa*. In spite of the clear-cut oxidation of quinic acid to citric acid accomplished by Fischer and Dangschat (24), it seems more probable that citric acid and quinic acid are derived from common or analogous precursors than that citric acid is derived directly from quinic acid. Clutterbuck (7) points out that the direct derivation of citric acid, according to

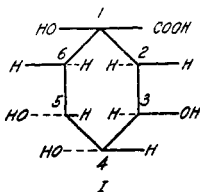

Fig. 1. Quinic acid

Emde's suggested equation in which quinic acid is assumed to be an intermediate, can give a theoretical yield of only 56 per cent, as against attainable yields of 87 per cent in *Aspergillus* fermentations.

An interesting example, however, of the controlling influence that can be exerted by "reconstructive" reasoning is afforded by the history of the structural proof for quinic acid. Emde (15) deduced the correct formula for this substance upon purely theoretical grounds. Karrer (31) arrived at a different conclusion from excellent experimental evidence. Fischer and Dangschat (22, 23) were able to show Karrer's error and substantiate Emde's original formula. The point is that quinic acid could not be intelligibly fitted into a biogenetic scheme until its structure was known, and the biogenetic scheme afforded an excellent check upon the structure deduced from purely organic chemical reasoning.

The question of the biogenetic origin of quinic acid is an important one from several points of view. It may well be said to occupy a key position in any scheme of biogenetic development. Its structure, as elucidated by Fischer and Dangschat, is shown in figure 1. It contains a carboxyl group

attached to a carbon atom which carries a hydroxyl group, this carbon atom being joined to two methylene groups. The origin of the carboxyl group in this particular situation is very important, as is the origin of the two methylene groups, for there is present in this configuration the ubiquitous isopropyl grouping. Perhaps of greater importance is the spatial arrangement on carbon atoms 3, 4, and 5 of the ring. Inspection shows that the arrangement is the same as that on carbon atoms 3, 4, and 5 of the naturally occurring hexoses *d*-glucose, *d*-mannose, and *d*-fructose as well as the *l*-varieties, when all are written in the acyclic form.

ORIGIN OF THE —COOH GROUP IN PLANT SUBSTANCES

Until the photosynthesis in plants of other compounds than the sugars has been demonstrated, photosyntheses must be assumed to start from the sugars produced by photosynthesis. In this case only oxidative or

dismutative processes operating upon $-\text{CH}_2\text{OH}$, $=\text{CHOH}$, $-\overset{\text{H}}{\underset{\text{O}}{\text{C}}}$, or

$=\text{C}=\text{O}$ can produce $-\text{COOH}$. We know that linkages between hexose molecules can be glycosidal linkages, 1-4 and 1-6 in the cases of reducing disaccharides, of which the 1-4 linkage is found in the important cellobiose and maltose. We may also have the 1-2 linkage, as in sucrose. In these cases we can conceive of the degradation of one of the chains giving rise to a $-\text{COOH}$ group as a final result. They may also give rise to methoxyl, ethoxyl, or ethylene oxide groups, which may be formed according to the ingenious scheme advanced by Browne and Phillips (5). For present purposes the fundamental conception of the carboxyl groups as a product of the oxidative or dismutative degradation of a chain is sufficient, but the additional concept of carbon-to-carbon linkages between hexose chains, or residues of such chains, is helpful. We have no certain knowledge of the existence of such linkages, but we have practically no knowledge of the nature of the carbohydrate linkages in a vast number of hemicelluloses, pectins, gums, and the like in which carboxyl groups are present.

In the uronic acids, the presence of a carboxyl group on carbon atom 6 can be conceived of as the product of the oxidation of the terminal $-\text{CH}_2\text{OH}$ group. The apparent non-existence of free uronic acids in plants indicates that this operation is not carried out on uncombined hexose molecules. Aside from the oxidation of a biose in which a terminal carboxyl is formed on one of the chains, there are only two alternatives: (a) the carboxyl on the second chain arose after its combination with hexose or other molecules by oxidation on carbon atom 6 alone; (b) it arose as a residuum of the oxidation of a hexose or other chain linked by a carbon-carbon bond to carbon atom 6 of the second chain. In view of the

relatively great difficulty in effecting the oxidation of carbon atom 6 *in vitro*, and its impossibility unless adequate protection is afforded the rest of the chain, and in view of the relative ease of biochemical oxidation starting at, e.g., carbon atom 2 of the fructose chain, it seems more logical to adopt the second alternative, viz., the carboxyl group of the uronic acids may arise from the oxidative degradation of a hexose or other chain (or chains) attached to carbon atom 6 by a carbon-to-carbon bond. Such a degradation may be roughly formulated as in figure 2.

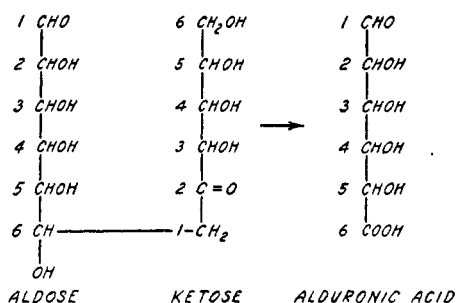

FIG. 2. Formation of carboxyl group

It is clear that many other types of union can give rise to terminal —COOH groups, but in most cases the more logical assumptions are based upon carbon-carbon linkages between atoms forming parts of carbohydrate chains.

ORIGIN OF THE TERMINAL METHYL GROUP AND METHYLENE GROUP

A similar line of thought accounts for the terminal methyl group better than does the postulation of a rather drastic process of reduction. The development of —COOH , for example, on carbon atom 2 of the fructose chain may be followed by decarboxylation and the formation of —CH_3 at carbon atom 1 (figure 3a), or the —CH_3 may appear at carbon atom 6 of the aldose chain (figure 3b). A similar action taking place on a carbon-carbon bond within a hexose chain may give rise to —CH_2 (figure 3c).

The existence of the desoxy sugars may be explained as well in this manner as by a dismutational action. The fact that the methylpentoses whose structures are known are related in a configurational sense to the hexoses in the following way,

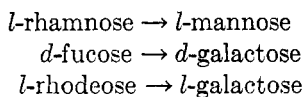

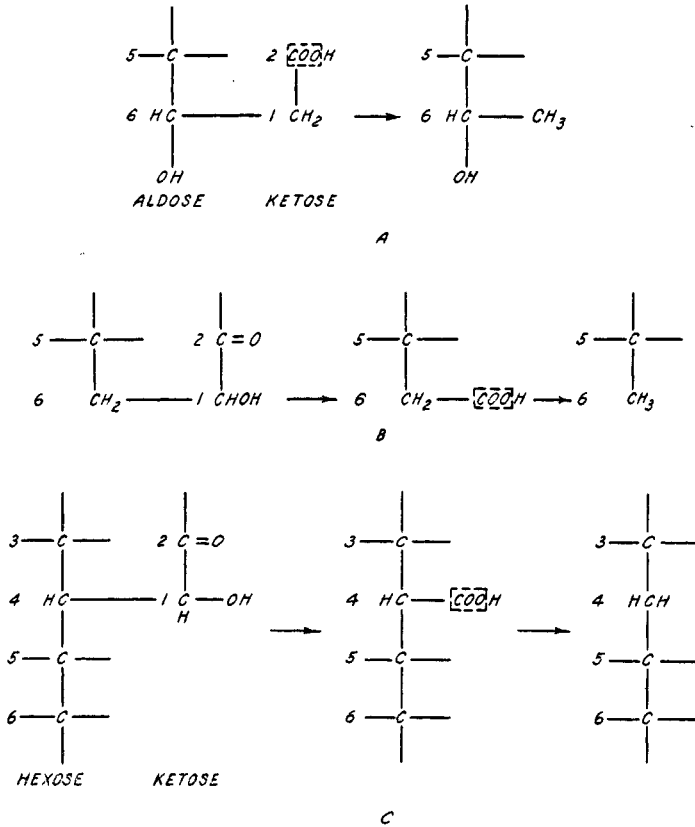

FIG. 3. Formation of methyl and methylene groups

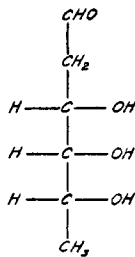

FIG. 4. Digitoxose

and the apparent non-occurrence of *l*-mannose and *l*-galactose in plants may be related to the peculiar configuration of digitoxose (figure 4) an-

nounced by Micheel (36), in the sense that these compounds arise, not from single hexose chains by dismutational processes, but from an original complex of perhaps several hexose chains or residues in which one or more carbon-carbon bonds are involved.

THE FUNDAMENTAL UNITY OF PLANT SUBSTANCES

The recurrence of the same or essentially similar structural units among plant substances, and the many times repeated coöccurrence of many of these units furnish a basis for the belief that the end products which we examine, although structurally quite dissimilar, may have arisen from common precursors, the latter stages of structural elaboration having taken place under slightly dissimilar conditions. Structural relationships in plant substances often do not appear in the conventional classifications of most organic and biochemical books. They must usually be developed by "reconstructive" methods. In the following discussion the dominant thought has been to demonstrate the possible common origin of widely

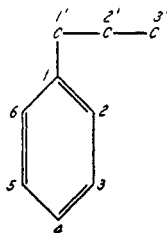
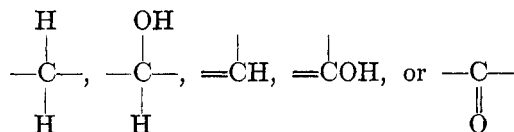

Fig. 5. Common C_6-C_3 form

diversified compounds occurring in higher plants, that origin being the usually occurring hexose sugars.

The special products of metabolism of the fungi have not been discussed, since it was felt that the new point of view could be developed more freely if not limited by older ideas based upon theories and observations in connection with fermentation phenomena.

Two principal types of naturally occurring molecules will be treated,—the "isoprene family" and the vast group in which the C_6C_3 grouping predominates. As Armstrong (1) has pointed out, the natural aromatic compounds may be conveniently classified, first, according to the length and state of oxidation of the side chain, and second, by the number of hydroxyl groups in the nucleus. The simplest types are as in figure 5, where theoretically C_1 may be:



C₂, may be:

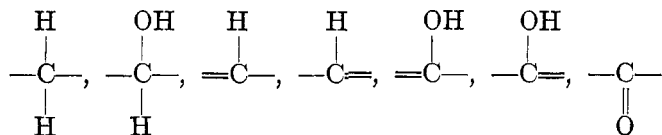

C₃, may be:

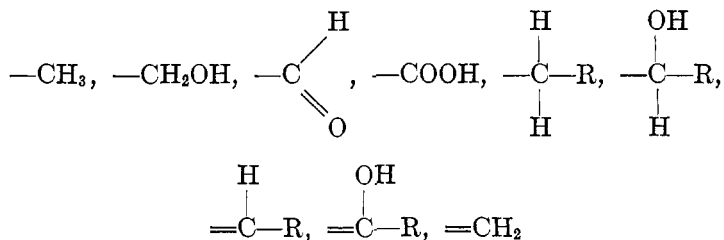

Not all of the above configurations have been observed in natural products, but examples are known of the major part of them. It follows that, in a formal development, the assumption is necessary that these configurations can be derived from

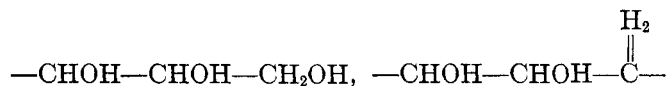

or from

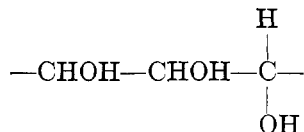

by the application of the ordinary oxidation and oxido-reduction mechanisms or the processes postulated for the formation of $-\text{CH}_2$ and $-\text{CH}_3$. The position and number of hydroxyls in the nucleus will be developed later.

A further assumption, fundamental to the conceptions to be developed, is in disagreement with the idea generally held that most plant products are formed by the union of small units resulting from sugar degradation. Collie (8) suggested that after molecules of great complexity have been built up from the product or products of photosynthesis, these undergo degradation to simpler compounds, and that conditions of slightly varying acidity or alkalinity may determine the actual constitutions of the final products. Clutterbuck (7) suggested that polysaccharides are intermediates in the biological syntheses of certain acids produced by molds.

He also brought forward the idea that this may be of rather general application. It may be considered that in regions of photosynthetic activity energy is consumed in the synthesis of these complexes, which in turn furnish the required energy to carry out the subsequent anoxidative processes of growth and metabolism. *The resulting end products, which can be isolated, may be the results of configurations already established by the mode of union in the original complexes.*

DERIVATION OF THE CINNAMIC ACID SERIES

The underlying configuration suggested by the known structure of cinnamic acid (figure 6) is found in the metasaccharonic type of acid of Kiliani (figure 7) (32). For purposes of formal development it is necessary to consider probable mechanisms for the formation of this or similar configurations in the plant. According to the argument developed above, relative

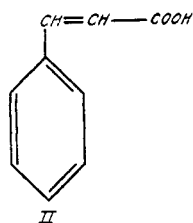

FIG. 6

FIG. 6. Cinnamic acid

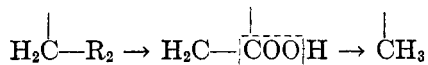

FIG. 7

FIG. 7. Metasaccharonic acid

to the arising of $-\text{COOH}$ and $-\text{CH}_2$ groups *in vivo*, it may be considered that $-\text{C}-\text{C}-$ linkages would exist on carbon atoms 3 and 6 of the hexose chain. The $-\text{CHO}$ group at carbon atom 1 is regarded as oxidized to the carboxyl group by known biological mechanisms. The derivation of III, the general metasaccharonic configuration, from an aldohexose, might then follow as in figure 8. Carbon atom 1 may be glycosidally linked, as may C_4 and C_6 . R_1 might be on C_4 .

The situation on C_6 might be $\text{HC}-\text{R}_2$, in which case the process indicated might form a terminal methyl group:



In this case, not a representative of the cinnamic acid series, but a member of the series with the side chain $-\text{CH}=\text{CHCH}_3$ would result.

Cinnamic acid itself can be derived by joining two molecules of III, as indicated in figure 9. The relationship between cinnamic acid and benzyl

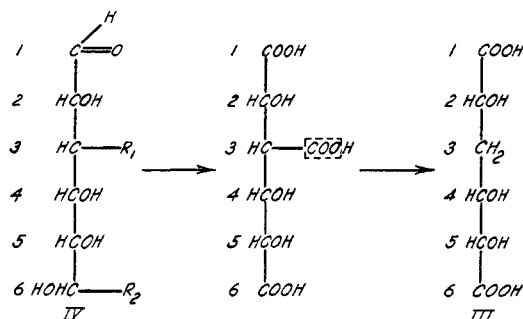

Fig. 8. Derivation of metasaccharonic acid

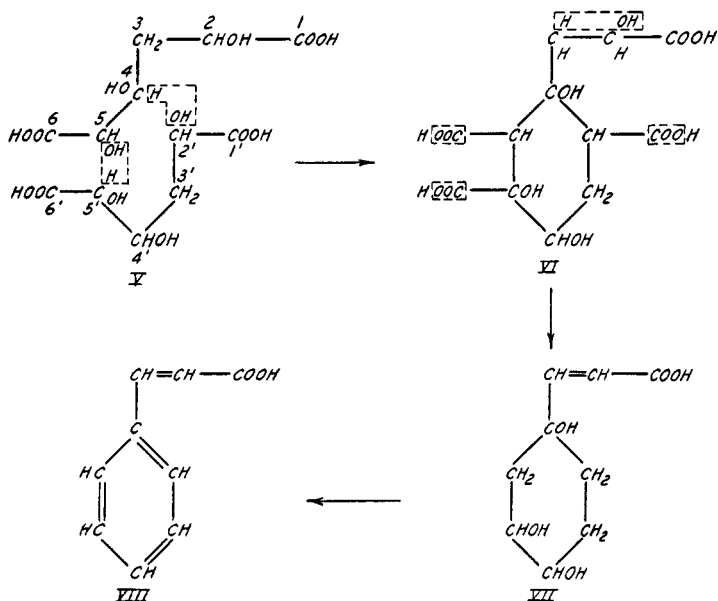

Fig. 9. Derivation of cinnamic acid

alcohol, benzaldehyde, and benzoic acid need only be suggested here. Clearly the side chain, formed from carbon atoms 1, 2, and 3 (or 4, 5, and 6), may be conceived of as being oxidized at any stage after that shown in formula V. As indicated above, the allyl and propenyl side chains may

be conceived of as arising because of a special situation at C_1 of the upper chain, which, if R_1 in formula IV were on C_4 , might just as well be C_6 of the original hexose chain.

The condensation shown as taking place between carbon atoms 5 and 5' and 4 and 2' may take place in three other ways, depending upon the source of $-H$ and $-OH$, but the result is the same in all cases, and subsequent dehydration within the nucleus results in the benzene ring.

It is important to apprehend that the condensation shown is conceived of as taking place not necessarily between two molecules of a metasaccharonic acid but *between two hexose molecules so joined with other chains that the metasaccharonic configuration is produced by degradation of the original condensed, but much larger, molecule. Nothing is specified as to the order in which these events may transpire.* For formal development, subsequently, the finally developed metasaccharonic type of molecule will be used. The limitations of graphic presentation prevent the use of the basic conception of the large molecule. In effect, carboxyl groups in subsequent developments represent points of union for chains.

THE MONOHYDROXYCINNAMIC ACID SERIES

In the formal development of the various monohydroxycinnamic acids (figure 10) it is necessary to use one molecule of III as derived above, and one molecule of dicarboxylic sugar acid (IX). The formation of the two terminal carboxyls in the case of the latter may be conceived of as having arisen in the manner postulated under the derivation of cinnamic acid. In this formal development no regard need be had for the stereochemical arrangement on the remaining carbon atoms, although it is clear that this may play an important part in directing the manner in which condensations and dehydrations may take place by the elimination of $-H$ from one carbon atom and $-OH$ from another.

Although all three of the monohydroxycinnamic acids are possible under this derivation, only the ortho and para forms have been found in nature. A few occurrences of *m*-hydroxybenzaldehyde indicate the probability that the meta form exists. The ortho variety is, of course, *o*-coumaric acid, and derived from it, or along with it in the same manner as shown in the relationships between cinnamic acid and benzoic acid, are saligenin, salicylic aldehyde, and salicylic acid.

The para form is found mostly in combinations in which the side chain is in a more highly oxidized form, as in apigenin, scutellarin, genkwanin, and campherol, although the free *p*-coumaric acid has been reported a number of times.

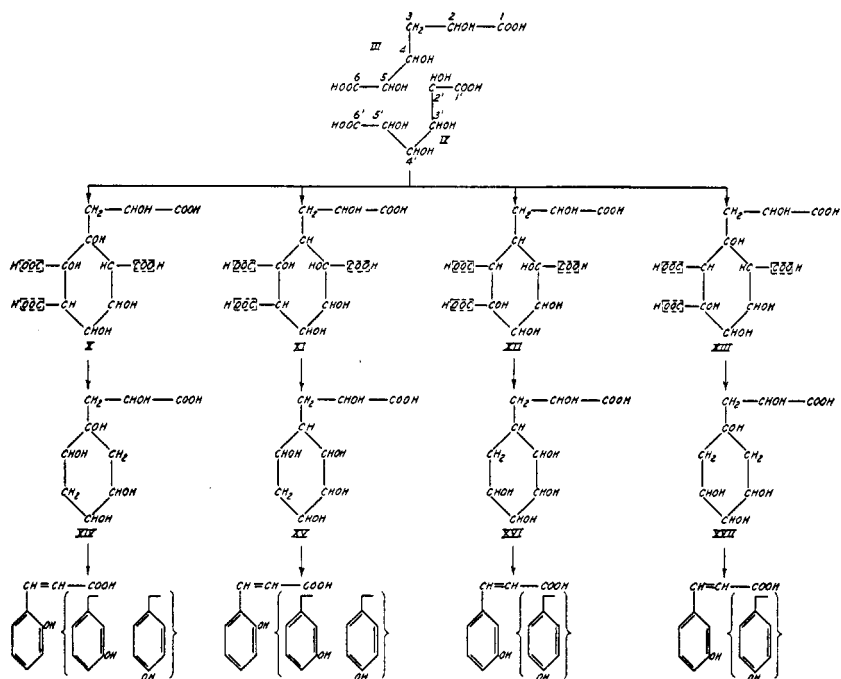

FIG. 10. Derivation of monohydroxycinnamic acids

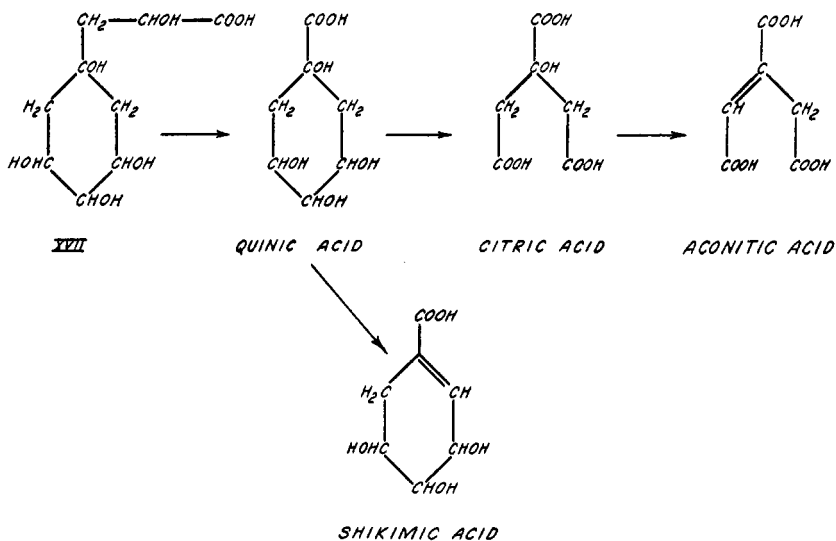

FIG. 11. The quinic acid series

DERIVATION OF QUINIC ACID

A slight variation in the course of the operations outlined in the derivation of the monohydroxy acids leads to quinic acid as the principal representative of a family of several acids. For convenience, the derivation can be carried out from formula XVII simply by oxidizing the side chain to $-\text{COOH}$ (figure 11). The relationship existing between quinic acid and the following acids was pointed out by Emde in 1931 (13), although at that time he seems to have abandoned his own idea of the structure of quinic acid and shikimic acid in favor of Karrer's formula (31). The relationship is much more apparent when based on Fischer's formula for quinic acid (23). Again it must be emphasized that the relationship shown is only a formal one and does not postulate the derivation in straightforward fashion as shown. It is much more probable that the course of subsequent oxidative degradation is determined by the situation existing in stage XIII with respect to combinations on extracyclic carbon atoms. In stage XIII the necessary arrangement exists to cause the degradation to take any of several courses under different conditions. Perhaps of considerable importance in lending some weight to the arrangement here postulated is the fact, already pointed out, that the stereochemical configuration on carbon atoms 3, 4, and 5 of XIII, and consequently, of quinic acid, is the same as that on carbon atoms 3, 4, and 5 of glucose, fructose, and mannose.

DERIVATION OF THE TERPENES

The biogenetic origin of the terpenes is a part of the whole problem of the origin of branched-chain compounds, as well as those containing six-membered rings and side chains of varying length.

It is of considerable interest to find that the terpenes may be closely related biogenetically, according to the present scheme, to the foregoing substances with which they appear to be also closely associated in occurrence. In fact, it was a search for a fundamental reason for the existence of the relationships shown by the author (28) to exist among the terpenes that led to the development of the system being discussed.

The terpene derivation must be done in two separate stages, which lead to two slightly different hypothetical "half-molecules" closely related to acetonedicarboxylic acid. These are finally united to give the desired configurations.

To develop the first half, we must refer to XVII (or XIII). If it be assumed now that the side chain is stabilized and oxidation takes place in the cycle, the result is XVIII (figure 12). It will be seen that the process is the same as that employed in the derivation of citric acid, except that the side chain has remained intact.

In the development of the second hypothetical terpene precursor

(figure 13), it is necessary to go further back to the original union of III and IX under "derivation of the monohydroxycinnamic acid series" (figure 10), and join them in a little different fashion. The orientation of III with respect to IX is simply reversed. XX is the desired other half of the terpene derivation. For present purposes, let XVIII be A and XX

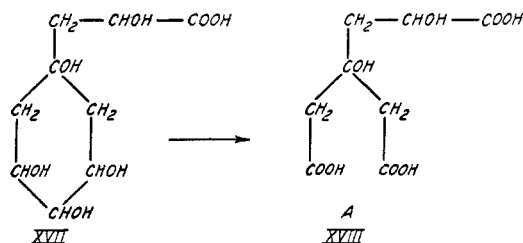

FIG. 12. A in terpene derivation

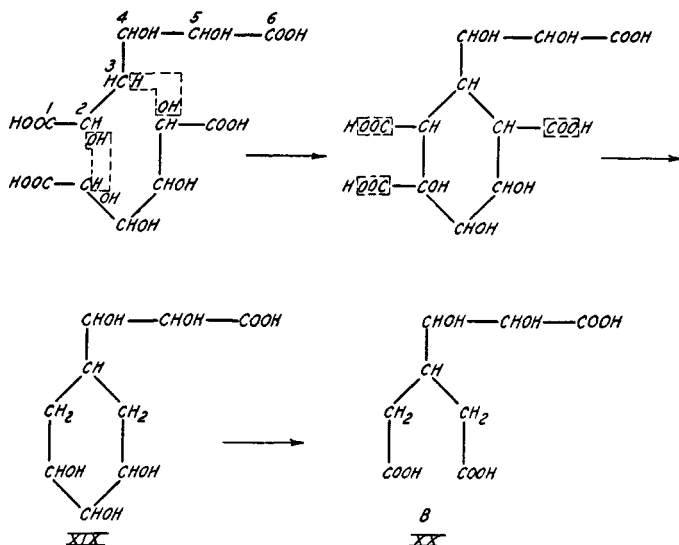

FIG. 13. B in terpene derivation

be B. There are clearly four combinations possible: A, B; A, A; B, B; and B, A. The combinations can be effected as shown in figure 14.

An alternative derivation of certain terpenes, probably more nearly what occurs, is shown in figure 15. If all the possible combinations of XVII and XIX are condensed as shown, all the terpenes are possible.

The four glycerols derived in figure 14 are identical with the ones postulated by the author (28) as underlying all the terpenes. The glycols

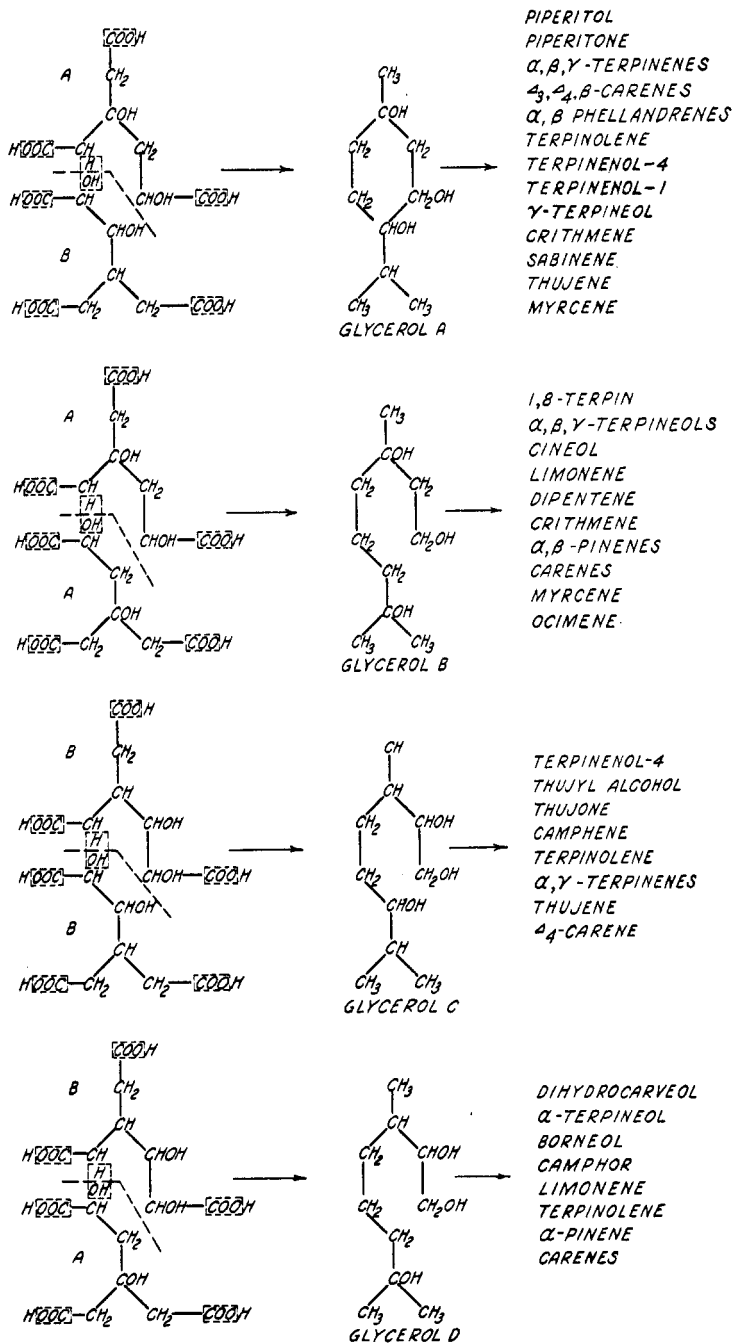

FIG. 14. Derivation of terpenes

rences that the associations of the various terpenes and terpene alcohols in plants conformed very closely to that required by their postulated origin.

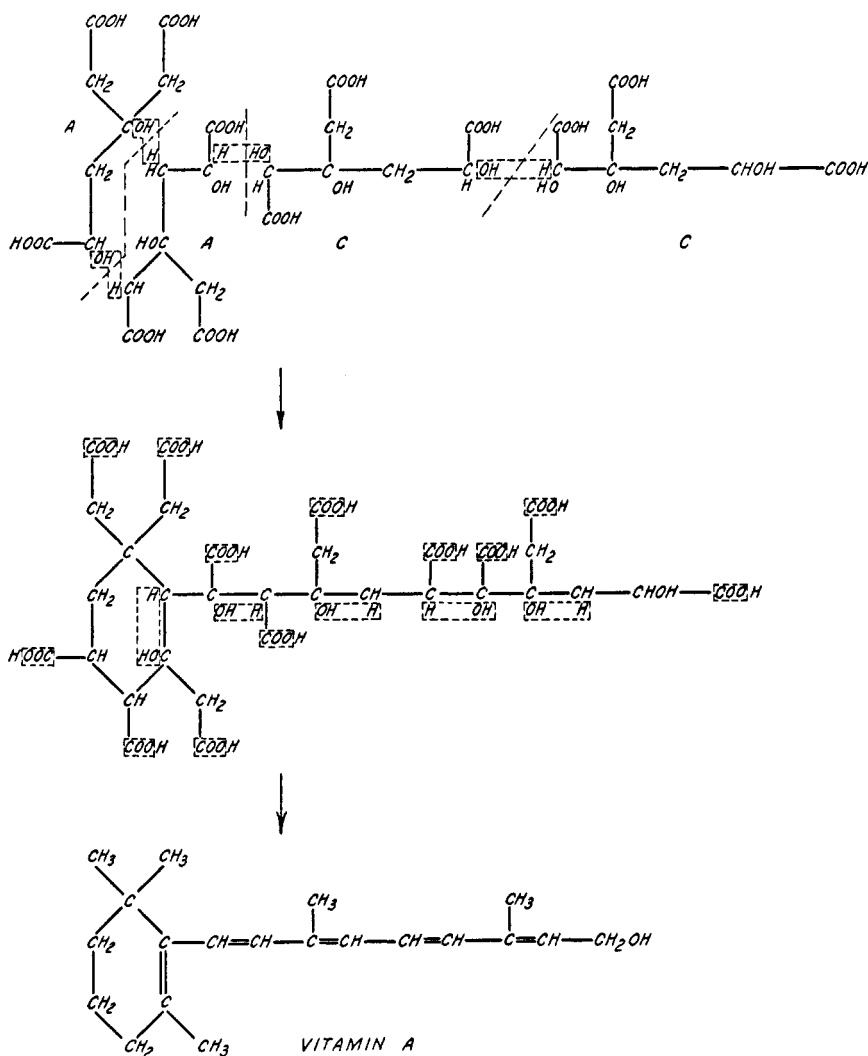

FIG. 17. Derivation of vitamin A

It will be observed that A and B are closely related to isoprene. There seems to be every reason to believe that by similar structural reasoning the entire "isoprene family" can be brought into harmony with the system developed. A few examples can be developed here, e.g., the derivation of

vitamin A according to the formula of Karrer (21, 30). Here will be utilized the progenitor, A, of the terpene derivation and a similar configuration, C (figure 16), which can be derived by a similar process from X or XIV. They may be arranged as in figure 17 to give a derivation of vitamin A.

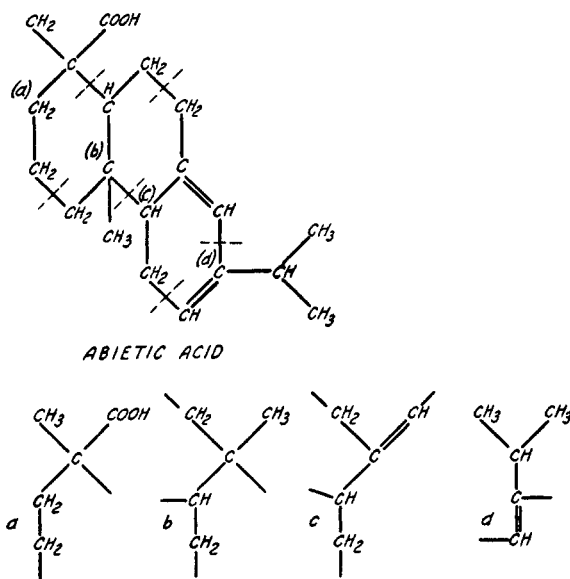

FIG. 18. Abietic acid and its subdivision into parts a, b, c, and d

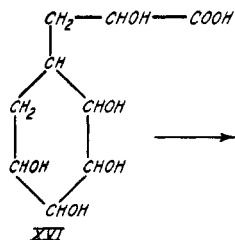

FIG. 19

FIG. 19. Derivation of part a in abietic acid

FIG. 20. Derivation of part b in abietic acid

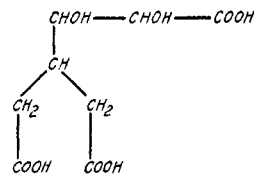

FIG. 20

DERIVATION OF ABIETIC ACID

According to Ruzicka (41) abietic acid has the formula shown in figure 18. It may be broken up into the four five-carbon atom fragments a, b, c, and d. Fragment a can be derived from XVI (figure 19); b is derived from XX (figure 20); c is derived from two hexose molecules or two dicarboxylic

sugar acids (figure 21); and d is the same as b. The full derivation of abietic acid is shown in figure 22.

Space limitation prevents the carrying out here of further derivations in the "isoprene group," but the methods used seem to be capable of wide extension.

The mysterious origin of the branched-chain sugar, apiose, is explainable in a similar manner in figure 23 and thus harmonized with the derivation of the terpenes. Stewart³ showed a possible derivation of the terpenes from apiose, the synthesis of which he postulated as arising by formaldehyde condensation.

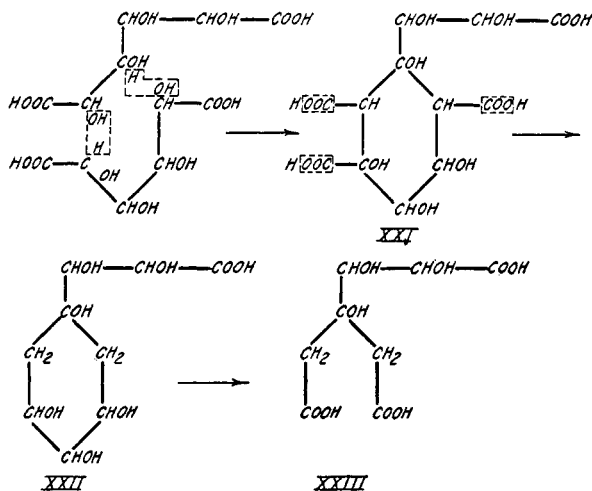

FIG. 21. Derivation of part c in abietic acid

ALIPHATIC HYDROCARBONS AND RELATED SUBSTANCES

The problem of the relation of *n*-heptane to the terpene system⁴ of synthesis is an interesting one. Heptane occurs in the oleoresinous secretions from *Pinus jeffreyi* and *Pinus sabiniana*, as well as in *Pseudotsuga macrocarpa*, in a manner exactly analogous to the occurrence of the terpenes, associated with resin acids of the abietic type which are evidently very closely related to, if not entirely identical with, the resin acids of many other pine oleoresins in which the volatile portion consists of terpenes. It is at least very suggestive to note that the *n*-heptane chain can be derived in a manner analogous to that in which the formation of the terpenes and resin acids was postulated.

If XX, which was B of the terpene derivation, be combined with

⁴ Reference 50, Vol. 2, p. 292.

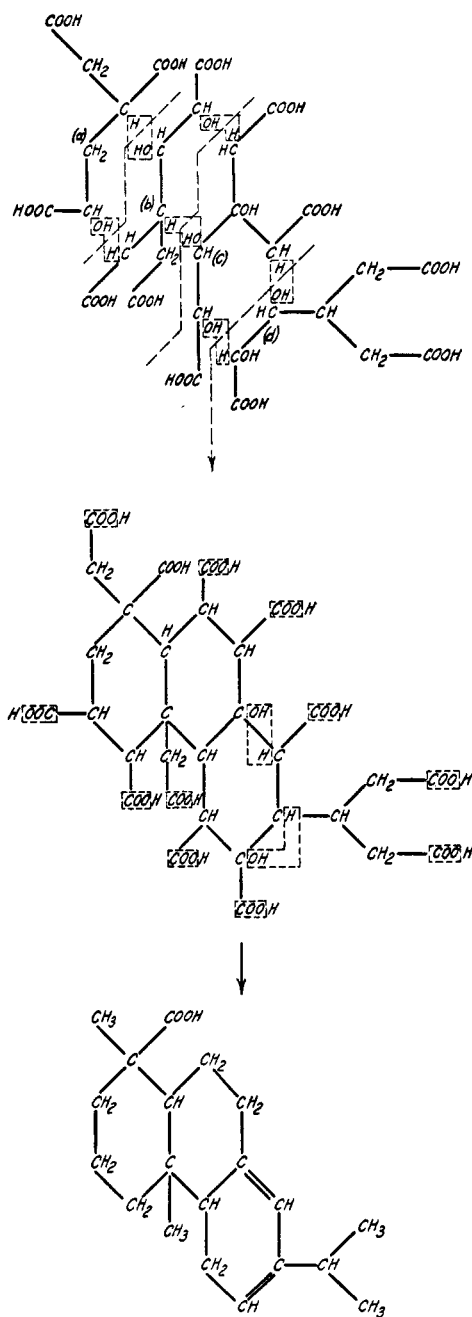

FIG. 22. Derivation of abietic acid

fragment a of the abietic acid derivation, which arose from XVI, the sequence shown in figure 24 seems possible.

With few exceptions, there appears to be a rough sort of periodicity of four in the occurrence of normal paraffins in higher plants. According to

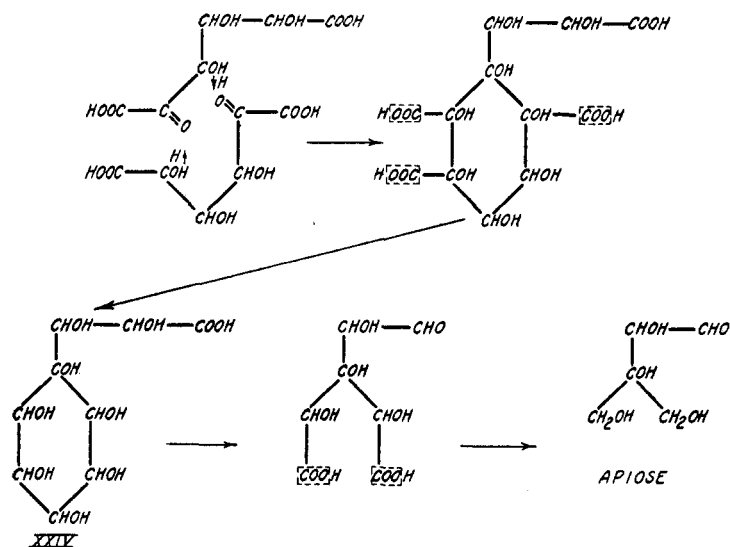

FIG. 23. Derivation of apiose

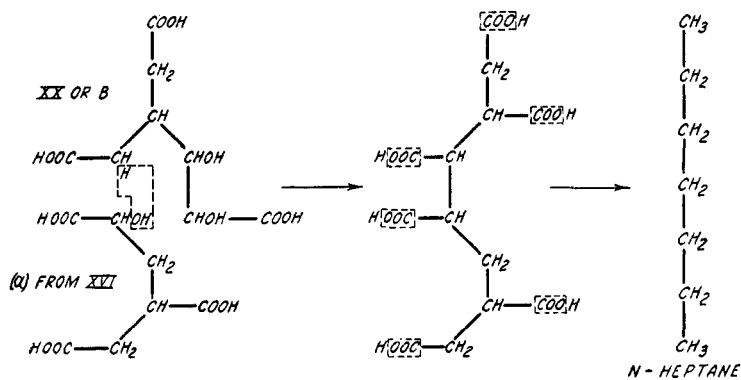

FIG. 24. Derivation of *n*-heptane

Chibnall and his coworkers (6) the usual plant and insect waxes may contain odd numbers of carbon atoms up to C_{37} . They list recorded occurrences, subject to earlier limitations of technic in identification, up to the year 1930 as follows: *n*-heptane, 7; *n*-pentadecane, 3; *n*-hexadecane, 1;

n-eicosane, 1; *n*-heneicosane, 1; *n*-docosane, 3; *n*-tricosane, 3; *n*-pentacosane, 1; *n*-hexacosane, 1; *n*-heptacosane, 11; *n*-octacosane, 1; *n*-nonacosane, 2; *n*-triacontane, 19; *n*-hentriacontane, 26; *n*-dotriacontane, 2; and *n*-pentatriacontane, 15. To these should be added at least two occurrences of *n*-undecane in *Pinus excelsa* (47) and *Pinus monticola* (25) and a suspected occurrence in *Pinus lambertiana* (46). Marion (35) reports the occurrence of *n*-nonane in *Sarothra gentianoides* L.

In the light of the investigations of Chibnall's school, it seems highly probable that many of the reported occurrences of normal hydrocarbons with even numbers of carbon atoms are in error, and that many other reported occurrences of pure hydrocarbons of high molecular weight really dealt with mixtures. It is a little suggestive that the curve of occurrences rises so abruptly at C₂₇, C₃₁, and C₃₅. The nineteen reported occurrences of C₃₀ hydrocarbons in all probability dealt with mixtures. However, Chibnall and his coworkers have abundantly proven the occurrence of C₂₅, C₂₉, and C₃₃ hydrocarbons, so that there is obviously no rigid periodicity of four; if it exists it is superimposed upon a periodicity of two.

It is easy to see how, starting with C₇, increments of four carbon atoms, derived perhaps from a (figure 24) or perhaps from other similar configurations, would build up in periods of four. If the tertiary carbon atom in a carries a hydroxyl group instead of hydrogen, the increment might be reduced to two.

When the above reasoning is applied to the saturated straight-chain dicarboxylic acids, no such regularity appears. The derivation of *n*-heptane above could give azelaic acid if the terminal carboxyl groups were retained. We have, however, higher acids as follows: sebacic (C₁₀), thapsic (C₁₆), rocellic (C₁₇), japanic (C₂₁), *n*-eicosanedicarboxylic acid (C₂₂), *n*-heneicosanedicarboxylic acid (C₂₃). No unsaturated dicarboxylic acids are known in plants above mesaconic acid:

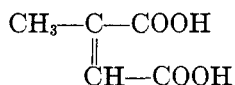

With a single exception, phloionic acid, C₁₆H₃₀(OH)₂(COOH)₂, no higher hydroxydicarboxylic acids have been found.

From condensations of the various "half-molecules" in the manner used in the derivation of *n*-heptane, almost any conceivable situation with regard to hydroxyl groups in the chain can arise. It seems at least possible that herein lies an explanation of the formation of the saturated dicarboxylic acids, the saturated monocarboxylic acids, the unsaturated monocarboxylic acids, the aliphatic alcohols and ketones, and the hydrocarbons, in all of which a straight carbon chain is present. The relatively few examples utilized here can certainly be greatly increased in number.

The formation of a particular compound or class of compounds may be determined by the situation in the vicinity of the terminal carboxyls, ease of decarboxylation, susceptibility to further oxidation, or relative stability in its chemical environment. The occurrence of double bonds, hydroxyls, or carbonyls within the chain may be determined by the position of hydroxyls and side chains in the original condensed compound.

It must be admitted that the biogenesis of the whole field of aliphatic hydrocarbons, alcohols, aldehydes, and acids is less satisfactorily explained by the general system here developed than are the other fields treated. On the other hand, they can be fitted into the general scheme, although with less assurance than in the other cases. We are not yet in full possession of information with respect to the regularities in the position of double bonds in the straight-chain olefinic monocarboxylic acids. A full consideration of the known structures now available does not reveal consistent regularities at all.

Evidence is not wanting of the validity of the application to fat synthesis of Collie's theory of successive dehydration and reverse hydration on carbohydrates.⁴

DERIVATION OF THE DIHYDROXYCINNAMIC ACID SERIES

Members of this series have not been found free in nature. However, the following compounds are found, upon inspection, to contain the carbon skeleton of the series, with the side chain in various stages of oxidation: coniferyl alcohol, cubebin, caffeic acid, umbelliferone, luteolin, morin, quercetin, gossypetin, fisetin, and quercetagetin. Protocatechuic alcohol, protocatechuic aldehyde, and protocatechuic acid are conceived to be related to this series as benzyl alcohol, benzaldehyde, and benzoic acid are to the cinnamic acid series. It is significant that the representatives of the 3,4-dihydroxy series predominate; a few occurrences only of the 2,4 series are reported; a single occurrence of 2-hydroxy-6-methoxybenzoic acid suggests the occurrence of members of the 2,6 series; the 2,3, the 3,6, and the 3,5 series are all lacking.

The 3,4 representatives are of great importance in numerous glucosides, especially of the γ -pyrone family and the anthocyanins.

The required configuration is given by the union of one molecule of metasaccharonic acid with a molecule of an α -ketodicarboxylic acid which may be conceived as arising from the oxidation of a ketose chain on which radicals were attached to carbon atoms 1 and 6, or from an aldose chain similarly connected, by oxidation on C₅ in the usual manner leading to acids like 5-ketogluconic acid. Thus, the necessary underlying chains are an aldose and a ketose, or two aldoses (figure 25).

⁴Reference 50, p. 294.

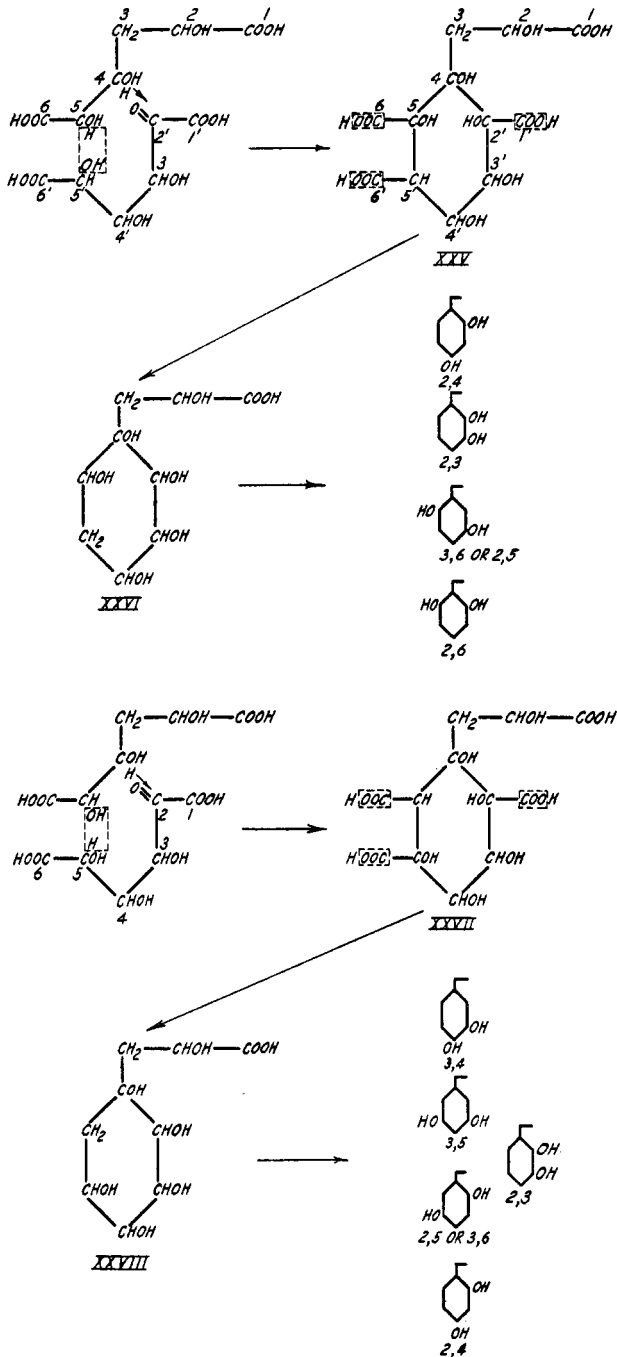

FIG. 25. Derivation of the dihydrocinnamic acid series

In accounting for the occurrence of only the 2,4- and the 3,4-dihydroxy compounds, the situation in XXV must be considered. Assume that carbon atom 4' is united glycosidally to R. Then the derivation may proceed as in figure 26. If dehydration goes as in XXX, a 2,4 product results; if as in XXXI, a 3,4 product is formed.

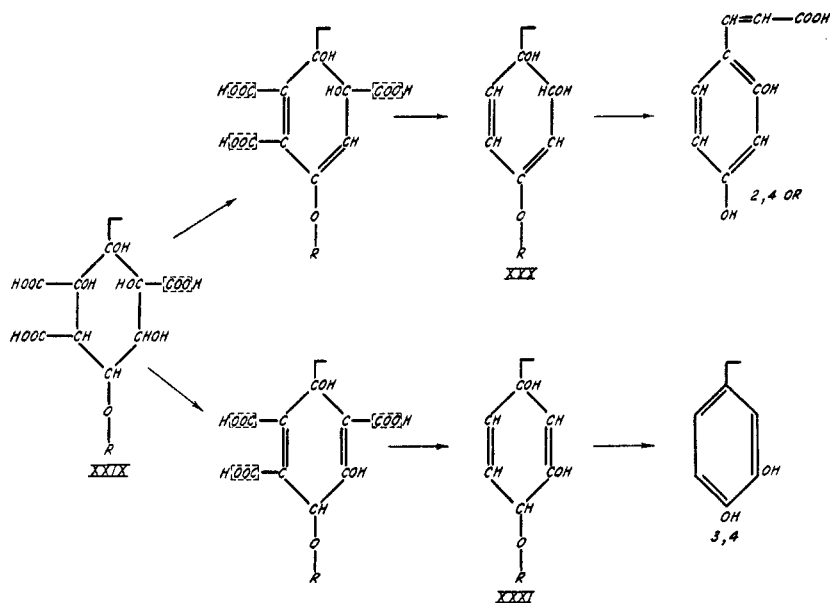

FIG. 26. Limitation of the dihydroxycinnamic acid series

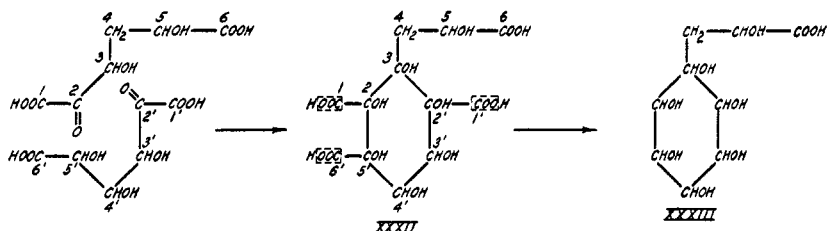

FIG. 27. Derivation of the trihydroxycinnamic acid series

DERIVATION OF THE TRIHYDROXYCINNAMIC ACID SERIES

Derivatives of this series found in nature are exemplified by the following:

- 2,4,6 derivatives: limettin, bergaptene
- 3,4,5 derivatives: tricetin, myricetin
- 2,4,5 derivative: aesculetin
- 2,3,4 derivatives: daphnetin, xanthotoxin

The necessary configuration is given by one molecule of a ketosaccharonic acid (derivable from fructose or as under the dihydroxycinnamic series) and one molecule of a ketodicarboxylic acid (derivable from fructose or as under the dihydroxycinnamic series) (figure 27). All trihydroxy derivatives are theoretically possible from XXXIII, but only the 2,4,6-, the 3,4,5-, the 2,4,5-, and the 2,3,4-trihydroxy derivatives have been found in nature.

It is striking that among the naturally occurring products, position 4 always carries a hydroxyl group. This may again be due to the bearing

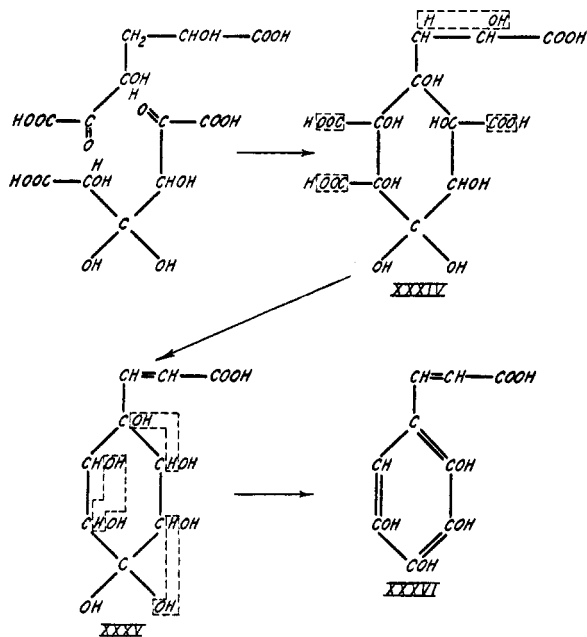

FIG. 28. Derivation of the tetrahydroxycinnamic acid series

of a glycosidally linked radical, which is later removed, on carbon atom 4' in XXXII.

The important gallic acid is conceived of as related to XXXII in the same way that benzoic acid is related to VI. It is also clear that inosite may be related to XXXIII by assuming the oxidation of the side chain to $-\text{COOH}$, and subsequent decarboxylation. Quercite may be related similarly to XXVI.

DERIVATION OF THE TETRAHYDROXYCINNAMIC ACID SERIES

Such compounds are rare, but apiol and fraxetin are representatives. They may be derived from one molecule of ketose and a second molecule of an oxidized ketose (figure 28).

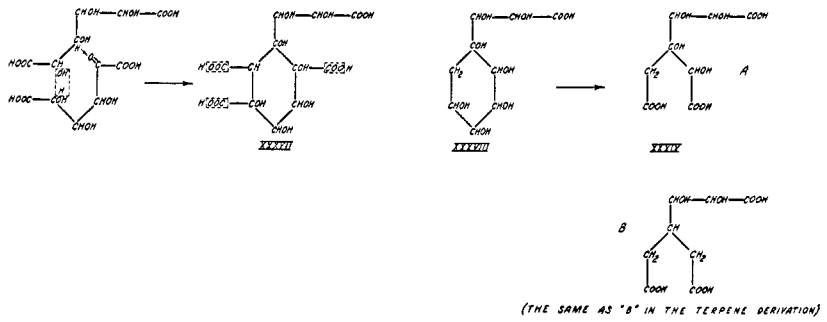

Fig. 29. Half-molecules of carvacrol and thymol

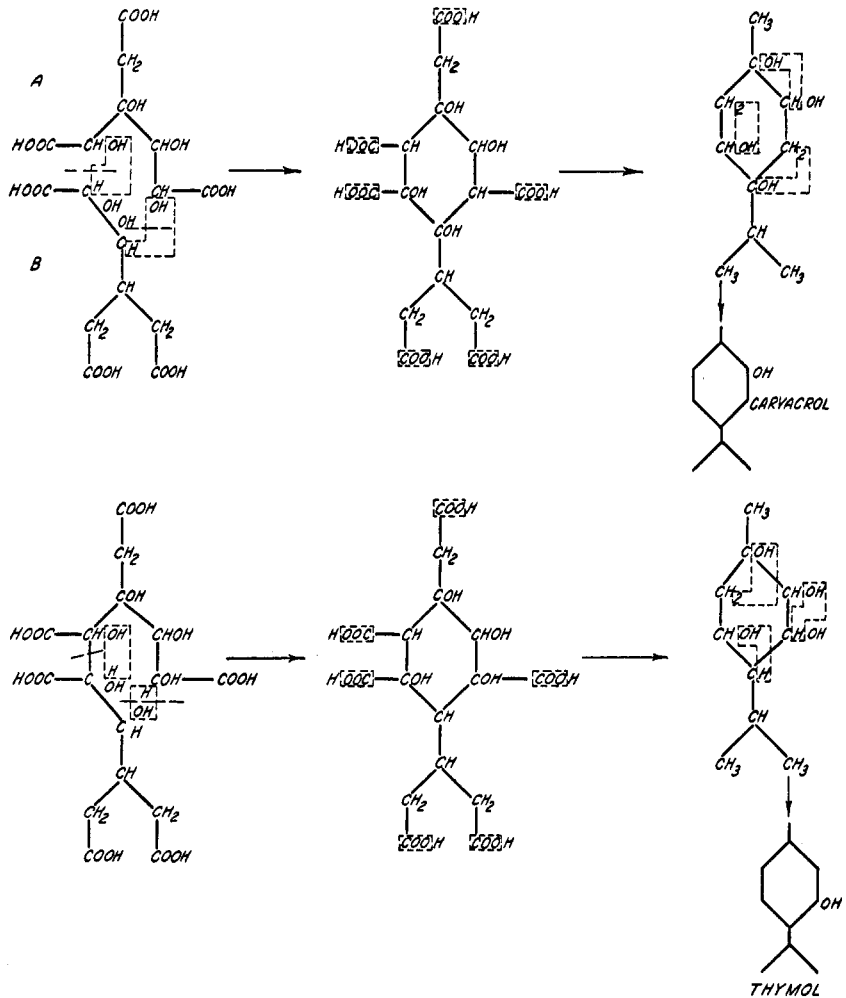

FIG. 30. Derivation of carvacrol and thymol

DERIVATION OF CARVACROL AND THYMOL

The derivation of carvacrol and thymol is similar to that of the terpenes, but one half of the molecule must be in a higher state of oxidation. Therefore, another half-molecule must be derived, using one molecule of ketose and one molecule of aldose (figure 29), and this must be combined with B of the terpene derivation as in figure 30.

Menthol is derivable in similar manner from B of the terpene derivation and another half-molecule A which must be derived. A is derived from a molecule of the saccharonic type as used before, and a molecule of the saccharonic type in which the $-\text{CH}_2$ group is in either the 5- or the 2-position (figure 31).

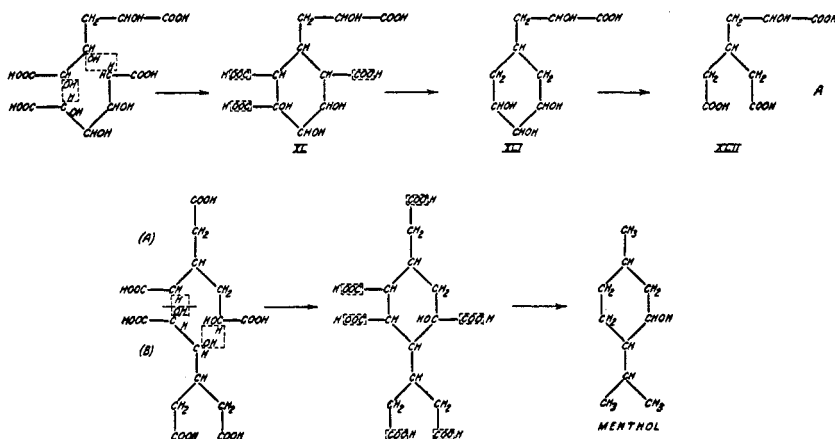

FIG. 31. Derivation of menthol

METHYLATION

The origin of methoxyl groups and the position of such groups remains to be harmonized with the scheme outlined above. It is clear that positions 3 or 4 in the ring may correspond to position 4 in the hexose chain. A methyl group in either of these positions may represent the residue of an attached chain according to the conception of Browne and Phillips (5). Both position 3 and position 4 in the ring were available for glycosidal linkage in the original hexose molecule. Position 2 in the ring is not found methylated in the mono- and the di-hydroxy series. It first appears in the trihydroxy series in methylated form. It may be more than a coincidence that, in the derivation of this series, two molecules of a fructose derivative are used and that carbon atom 2 of the fructose chain is carbon atom 2 of the ring. Although the corresponding situation exists in the derivation of the dihydroxy group, it is seen that here reversed orientation of the fruc-

tose molecule makes carbon atom 2 of fructose become 3 or 5 in the ring. In the derivation of the trihydroxy group, on the contrary, the two fructose chains must be oriented so that carbon atoms 2 of the chains fall in positions

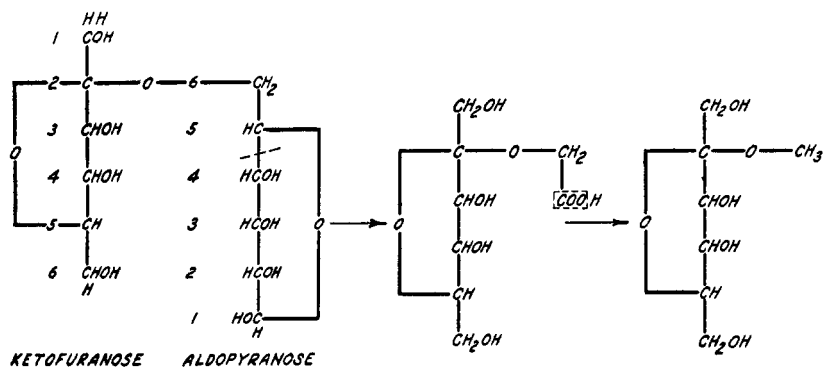

FIG. 32. Development of methoxyl group

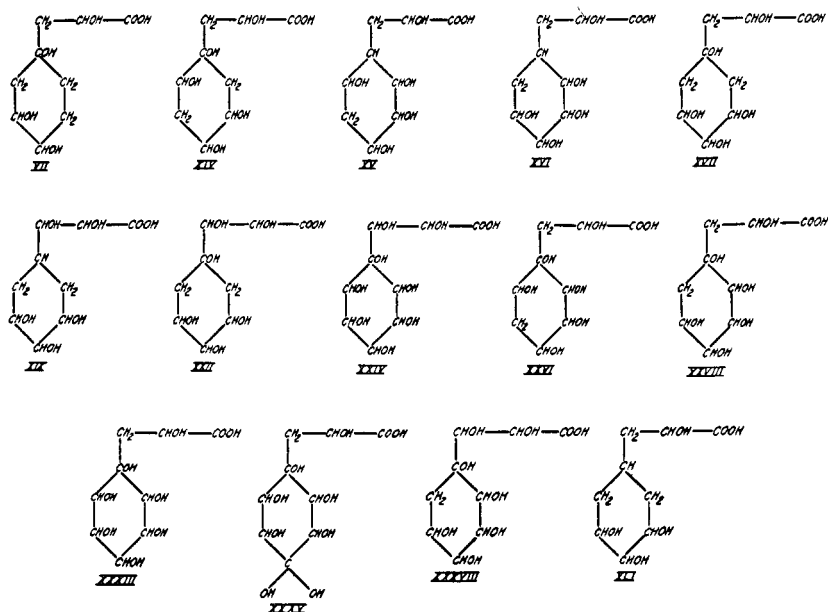

FIG. 33. Decarboxylated intermediates utilized in the foregoing formulations

2 and 6 in the ring. In the ring, positions 2, 3, 4, and 5 are the only ones that occur methylated. Positions 2 and 6 are never occupied simultaneously by methoxyl groups.

The scheme in figure 32 showing the possible development of methoxyl is

TABLE 1

Acids derivable by simple oxidation from the compounds indicated in figure 33

ACID	DERIVABLE FROM
Propionic acid, $\text{CH}_3\text{CH}_2\text{COOH}$	VII, XVI, XIX, XLI by way of CH_2COOH or $\text{CH}(\text{COOH})_2$ or CH_2COOH $\text{CH}(\text{COOH})_2$ CH_2COOH $\text{CH}(\text{COOH})_2$
Butyric acid, $\text{C}_3\text{H}_7\text{COOH}$	XVI, XIX, XLI
Isobutyric acid, $(\text{CH}_3)_2\text{CHCOOH}$	XVI, XIX, XLI
<i>n</i> -Valeric acid, $\text{C}_4\text{H}_9\text{COOH}$	Not possible
Isovaleric acid, $(\text{CH}_3)_2\text{CHCH}_2\text{COOH}$	XLI
Methacrylic acid, $\text{CH}_2=\text{C}(\text{CH}_3)\text{COOH}$	VII, XVII, XIX, XXII, XXVIII
Angelica and tiglic acids, CH_3CCOOH	VII, XV
	 CH_2CH
β , β -Dimethylacrylic acid, $(\text{CH}_3)_2\text{C}=\text{CHCOOH}$	VII, XVII, XIX, XXII
Malonic acid, $\text{CH}_2(\text{COOH})_2$	VII, XIV, XV, XVI, XVII, XIX, XXII, XXVI, XXVIII, XXXIII, XXXV, XXXVIII, XLI
Succinic acid, $\text{C}_2\text{H}_4(\text{COOH})_2$	VII, XV, XVI, XIX, XLI
Glutaric acid, $(\text{CH}_2)_3(\text{COOH})_2$	XVI, XIX, XLI
Fumaric acid, HOOCCH	VII, XIV, XV, XVI, XVII, XIX, XXII, XXVI, XXVIII, XXXIII, XXXV, XXXVIII, XLI
	 CHCOOH
Maleic acid, CHCOOH	VII, XIV, XV, XVI, XVII, XIX, XXII, XXVI, XXVIII, XXXIII, XXXV, XXXVIII, XLI
	 CHCOOH
Mesaconic acid, CH_3CCOOH	VII, XIV, XV, XVII, XIX, XXII
	 CHCOOH
Tricarballic acid, CH_2COOH	XVI, XIX, XLI
	 CHCOOH CH_2COOH
Aconitic acid, CH_2COOH	VII, XIV, XV, XVII, XXII, XXVIII
	 CCOOH CHCOOH

TABLE 1—*Concluded*

ACID	DERIVABLE FROM
α, β -Dihydroxy- α -methylbutyric acid, $\text{CH}_3\text{CHOHC}(\text{OH})\text{COOH}$	XIV, XXVI
$\begin{array}{c} \\ \text{CH}_3 \\ \\ \text{Malic acid, CH}_2\text{COOH} \end{array}$	VII, XIV, XVII, XXII, XXVIII
$\begin{array}{c} \\ \text{CHOH} \\ \\ \text{CH}_2\text{COOH} \\ \\ \text{Tartaric acid, CHOHCOOH} \end{array}$	VII, XIV, XV, XVI, XVII, XIX, XXII, XXVI, XXVIII, XXXIII, XXXV, XXXVIII, XLI
$\begin{array}{c} \\ \text{CH}_2\text{COOH} \\ \\ \text{Citric acid, C}(\text{OH})\text{COOH} \\ \\ \text{CH}_2\text{COOH} \\ \\ \text{Isocitric acid, CH}_2\text{COOH} \end{array}$	VII, XIV, XVII, XXII, XXVIII
$\begin{array}{c} \\ \text{CHCOOH} \\ \\ \text{CH}(\text{OH})\text{COOH} \end{array}$	XV, XVI

supplementary to those shown by Browne and Phillips (5). Other similar possibilities at once suggest themselves.

The decarboxylated intermediates utilized in the foregoing formulations are assembled in figure 33. Systematic combination of these structures, as indicated in figure 15, extends the possibilities over a very large field.

The acids shown in table 1 may be derived from them by simple oxidation.

NITROGENOUS SUBSTANCES

A generalized scheme of phytosynthesis should be applicable to the naturally occurring nitrogenous compounds, and especially to the amino acids upon which seems to rest the whole structure of protein and alkaloid synthesis (39).

As pointed out by Stewart (50) the initial steps by which nitrogen as nitrate from the soil is made to appear in combination with carbon, hydrogen, oxygen, and sometimes sulfur and phosphorus, are still obscure. However, considerable evidence is found of the existence in the plant of a hexose-nitrogen compound in which an amino group occurs on the second carbon

atom of the hexose chain. Diehl (9) affirms the identity of vegetable chitin with animal chitin and Van Iterson (29) has confirmed the same thing by means of x-ray diagrams.

Vestigial evidence is found in the formula for lactoflavin of Kuhn (34), and in the accepted formulas for inosic acid and adenosin (figure 34).

In nearly all the known amino acids, if the carboxyl group be assumed to represent carbon atom 1 of an original hexose chain, a nitrogen atom is

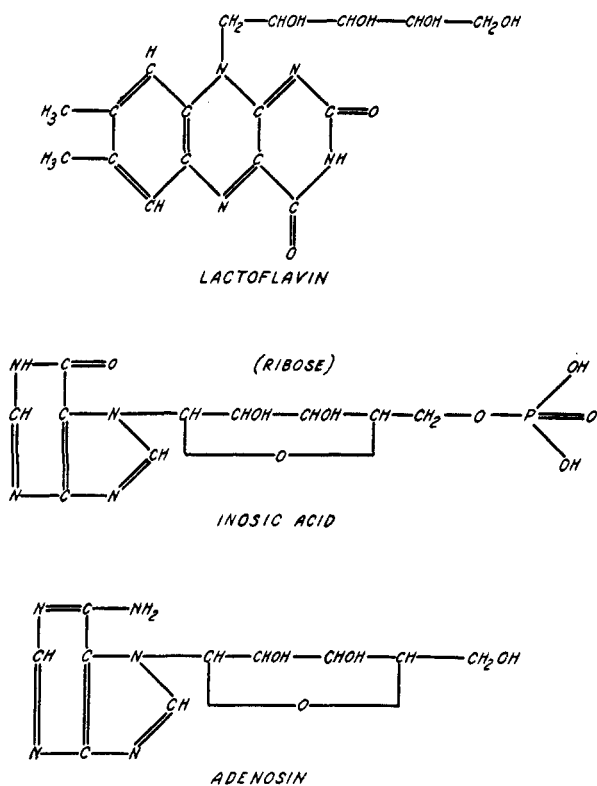

FIG. 34. Evidence for existence of a hexose-nitrogen compound

found attached to carbon atom 2. Furthermore, an examination of the formulas of the amino acids shows a very marked recurrence of the three-carbon atom chain that is so prevalent among non-nitrogenous bodies. It is distinct in the members of the series shown in figure 35. In the remaining members the chain is present, although not in such pronounced form. It is at once suggested that the application of the methods used in the non-nitrogenous derivations to condensations involving a 2-amino-hexose chain should be instructive.

If a molecule of a 2-aminohexose derivative, analogous to the saccharonic acid configuration previously used, be condensed with a molecule of the

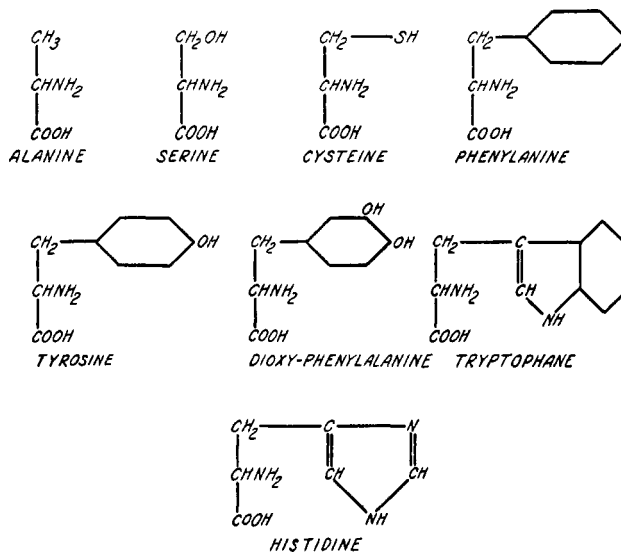

FIG. 35. Recurrence of the three-carbon atom chain in amino acids

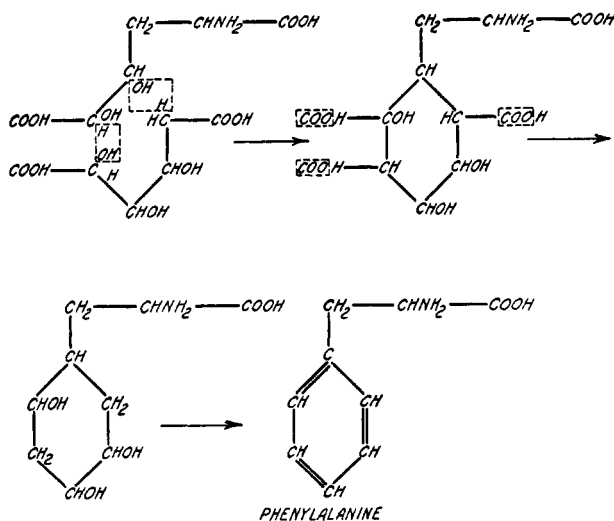

FIG. 36. Derivation of phenylalanine

saccharonic acid type, the sequence shown in figure 36 appears, leading to phenylalanine. The derivations of tyrosine and dihydroxyphenylalanine

follow naturally, as in the similar derivations of the hydroxycinnamic acid series.

If now, the various decarboxylated products that were utilized in the derivations of the non-nitrogenous compounds be written in α -amino acid form, the series of intermediates shown in figure 37 becomes possible. In this series the numbering is the same as before, with the prefix "N."

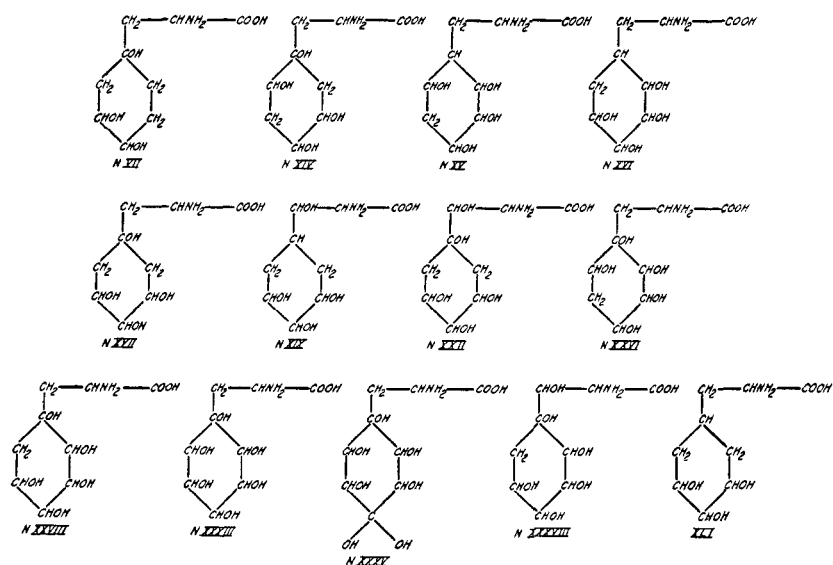

FIG. 37. Decarboxylated intermediates written in α -amino acid form

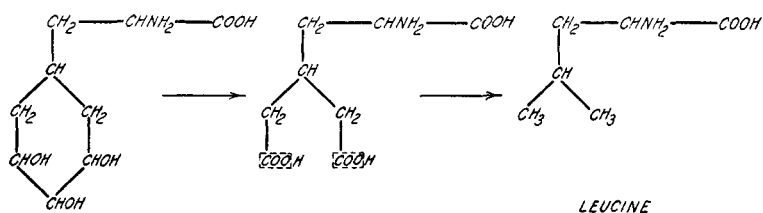

FIG. 38. Derivation of leucine

Oxidation of the cycle, in a manner analogous to the derivation of the terpene "half-molecules," gives several amino acid derivations directly. Thus oxidation of N XII gives leucine, as shown in figure 38. Norvaline may be conceived as derived from N XVI; α -aminobutyric acid from N XV; aspartic acid from N XXVI, N XXXIII, or N XXXV; glutamic acid from N XV; and oxyglutamic acid perhaps from N XIX. Proline seems to require as a precursor a cyclization between a hydroxyl group and the

amino group. This might follow as indicated in figure 39. A similar derivation of oxyproline from N XXXIII is at once suggested.

Condensation of two molecules of α -aminohexose derivatives in the same manner as before should lead to some of the diamino acids. A derivation of ornithine is shown in figure 40. Elimination of ammonia and the use

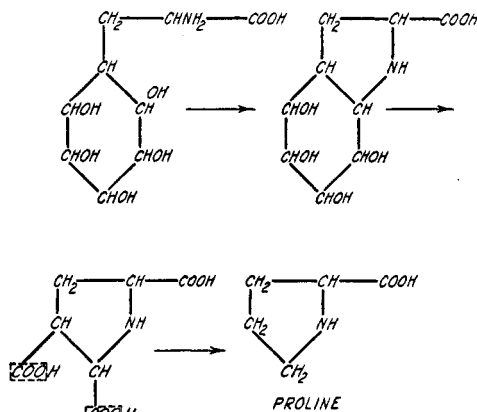

FIG. 39. Derivation of proline

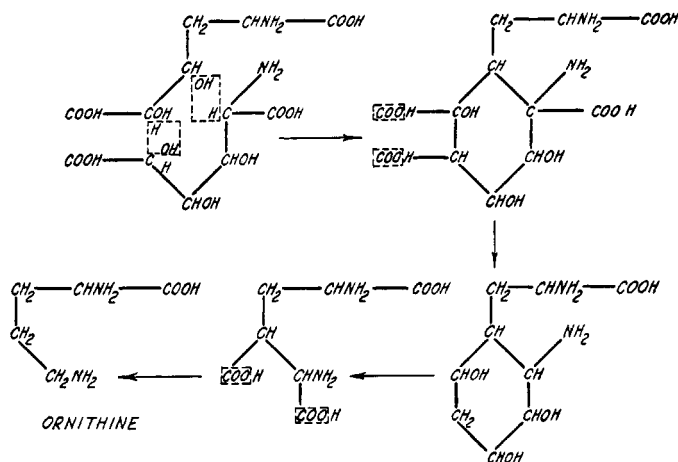

FIG. 40. Derivation of ornithine

of other hydroxylated configurations makes possible a large series of pyrrolidine and pyrrole derivatives. A reversal of the orientation as in the condensation in figure 40 may lead to lysine, as in figure 41. In histidine, arginine, and tryptophane, the same chain, $\text{-CH}_2\text{-CHNH}_2\text{-COOH}$, is present as in the other amino acids, but the derivation of the other parts of the molecules is more obscure.

Glycine, alanine, serine, and cysteine seem to offer no special difficulties, once the underlying 2-amino sugar is assumed to exist. Valine seems to be a special case in which some such configuration as shown in figure 42 is required to fit it into the scheme. The derivation of *o*-aminobenzaldehyde or *o*-aminobenzoic acid seems rather important as the starting point for a large number of compounds. A possible derivation is shown in figure 43. The type of condensation shown in this figure, amplified by using the various modifications already employed in other connections, gives a further wide range of possible derivatives.

Only a beginning has been made here in the derivation of the nitrogenous substances, and those related compounds containing sulfur have not been treated. Completeness has not been the aim; rather, an attempt has been made to lay a foundation in harmony with the derivation of the non-nitrogenous groups.

CONCLUSION

The intricate problems of phytosynthesis cannot be solved by mere structural formulations but the latter, properly interpreted, can suggest lines of laboratory approach that have been almost entirely lacking. The foregoing formalized presentation of a coordinated and unified method of regarding some of the phases of phytosynthesis strongly suggests that such lines of laboratory approach must be radically different from those of conventional organic methods.

There is no experimental testimony in support of the type of union between hexose chains that is postulated as the principal reaction involved in the development of all the phytosyntheses that have been worked out in this paper. Yet the comparative simplicity and uniformity in character of the subsequent derivations, the relating in synthesis of classes of compounds that are related physiologically, and, above all, the apparently very broad possible application of the methods involved give weight to the belief that fundamental relationships are being approached. The underlying suppositions can be said then to constitute a sort of pragmatism which may approach the rank of a theory if and when they receive the support of laboratory evidence. If, in the meantime, they may aid in unifying thought in the field of phytosynthesis and stimulating a new type of laboratory approach, they will have served a sufficient purpose.

The author wishes to acknowledge with deep gratitude the helpful criticism and stimulating advice of Professor Edward Kremers, whose many former students will readily recognize and properly place the source of inspiration for the type of reasoning employed in this contribution.

REFERENCES

- (1) ARMSTRONG, E. F.: *Sci. J. Roy. Coll. Sci.* **3**, 46-52 (1932).
- (2) ASTENGO, R.: *Riv. ital. essenze profumi* **7**, 5 (1925); *Chem. Abstracts* **19**, 2727.
- (3) BERNHAUER, K.: *Grundzüge der Chemie und Biochemie der Zuckerarten*, pt. 3. Berlin (1933).
- (4) BOGERT, M.: *Chem. Rev.* **10**, 265-94 (1932).
- (5) BROWNE, C. A., AND PHILLIPS, M.: *J. Wash. Acad. Sci.* **25**, 517-24 (1935).
- (6) CHIBNALL, A. S., PIPER, S. H., POLLARD, A., WILLIAMS, E. F., AND SAHAI, P. N.: *Biochem. J.* **28** (II), 2187-208 (1934).
- (7) CLUTTERBUCK, P. W.: *J. Soc. Chem. Ind.* **55**, 55-61T (1936).
- (8) COLLIE, J. N.: *J. Chem. Soc.* **91**, 1806-13 (1907).
- (9) DIEHL, J. M.: *Chem. Weekblad* **33**, 36-8 (1936).
- (10) EMDE, H.: *Pharm. Acta Helv.* **4**, 121-8 (1929).
- (11) EMDE, H.: *Naturwissenschaften* **17**, 699-703 (1929).
- (12) EMDE, H.: *Naturwissenschaften* **18**, 539-42 (1930).
- (13) EMDE, H.: *Ber. d. Math. Phys. Klasse der Sächsischen Akademie d. Wissenschaften* **83**, 219-37 (1931).
- (14) EMDE, H.: *Helv. Chim. Acta* **14**, 881-911 (1931).
- (15) EMDE, H.: *Apoth. Ztg.* **32**, 601-2 (1917).
- (16) EMDE, H.: *Apoth. Ztg.* **44**, 1125-7 (1929).
- (17) EMDE, H.: *Apoth. Ztg.* **47**, 1015-9 (1932).
- (18) EMDE, H.: *Apoth. Ztg.* **47**, 1418-21, 1433-6 (1932).
- (19) EMDE, H., AND HORNEMANN, T.: *Arch. Pharm.* **269**, 336-40 (1931).
- (20) VON EULER, H.: *Grundlage und Ergebnisse der Pflanzenchemie*, Vol. 3, p. 219. Braunschweig (1909).
- (21) VON EULER, H. KARRER, P., KLUSSMANN, E., AND MORF, R.: *Helv. Chim. Acta* **15**, 506 (1932).
- (22) FISCHER, H. O. L.: *Ber.* **54**, 775-84 (1921).
- (23) FISCHER, H. O. L., AND DANGSCHAT, G.: *Ber.* **65**, 1009-31 (1932).
- (24) FISCHER, H. O. L., AND DANGSCHAT, G.: *Helv. Chim. Acta* **17**, 1196-9 (1934).
- (25) FOOTE, P. A., AND MIROV, N. T.: *J. Am. Pharm. Assoc.* **22**, 828-34 (1933).
- (26) FRANCESCONI, L.: *Riv. ital. essenze profumi* **10**, 2, 33 (1928).
- (27) FRANCESCONI, L.: *Riv. ital. essenze profumi* **11**, 33-6 (1929).
- (28) HALL, J. A.: *Chem. Rev.* **13**, 479-99 (1933).
- (29) VAN ITERSON, G., MEYER, K. H., AND LOTMAR, W.: *Rec. trav. chim.* **55**, 61-3 (1936).
- (30) KARRER, P., MORF, R., AND SCHÖPP, K.: *Helv. Chim. Acta* **14**, 1431-6 (1931).
- (31) KARRER, P., WIDMER, R., AND RISO, P.: *Helv. Chim. Acta* **8**, 195-202 (1925).
- (32) KILIANI, H.: *Ber.* **18**, 642-5 (1885).
- (33) KREMERS, R. E.: *J. Biol. Chem.* **50**, 31-4 (1922).
- (34) KUHN, R., RUDY, H., AND WEYGAND, F.: *Ber.* **68B**, 625-34 (1935).
- (35) MARION, S. J.: *Dissertation*, Columbia University, 1932.
- (36) MICHEEL, F.: *Ber.* **63**, 347-59 (1930).
- (37) READ, J.: *Chem. Rev.* **7**, 1-50 (1930).
- (38) ROBINSON, R.: *J. Chem. Soc.* **111**, 762-8 (1917).
- (39) ROBINSON, R.: *J. Chem. Soc.* **111**, 876-99 (1917).
- (40) ROBINSON, R.: *Proc. Univ. Durham Phil. Soc.* **8**, (Pt. 1), 14-9 (1927-8).
- (41) RUZICKA, L., DE GRAAFF, G. B. R., AND MULLER, H. J.: *Helv. Chim. Acta* **15**, 1300-3 (1932).

- (42) SCHMALFUSS, H.: *Z. angew. Chem.* **43**, 500-3 (1930).
- (43) SCHÖPF, C.: Ninth Intern. Congr. Pure Applied Chem., Vol. V (1934).
- (44) SCHÖPF, C.: *Ann.* **497**, 1-21 (1932).
- (45) SCHÖPF, C., AND OECHLER, F.: *Ann.* **523**, 1-29 (1936).
- (46) SCHORGER, A. W.: *U. S. For. Serv. Bull.* **119**, 22 (1913).
- (47) SIMONSEN, J. L., AND RAU, M. G.: *Indian Forest Records* **9** (IV) Pt. II, 6-12 (1922).
- (48) SINGLETON, F.: *Chemistry & Industry* **50**, 989-94 (1931).
- (49) SMEDLEY, I.: *J. Chem. Soc.* **99**, 1627-33 (1911).
- (50) STEWART, A. W.: *Recent Advances in Organic Chemistry*. London (1931).
- (51) WAGNER-JAUREGG, TH.: *Ann.* **496**, 52-77 (1932).